

SITE 1032 HOLE A CORE 1R CORED 184.5 - 194.1 mbsf

Meter	Graphic Lith.	Section	Age	Structure	Disturb.	Sample	Description
1		1	Quaternary	— — — ~ ~	×××× ×××× ×××× ××××	S PP	CLAYEY SILT to SILTY CLAY and SILT Major Lithology: Greenish gray SILTY CLAY to CLAYEY SILT with local bioturbation. Minor Lithology: Thin beds of SILT.

SITE 1032 HOLE A CORE 2R CORED 194.1 - 203.7 mbsf

Meter	Graphic Lith.	Section	Age	Structure	Disturb.	Sample	Description
1		1	Quaternary	~ ~ ~ ~ △ — — —	×××× ×××× ×××× ×××× ×××× ×××× ××××	PP S S IW PP	CLAYEY SILT to SILTY CLAY and SILT Major Lithology: Greenish gray CLAYEY SILT to SILTY CLAY with local color variations, planar laminae, and bioturbation. Minor Lithology: Thin beds of SILT to SANDY SILT with sharp bases, plane parallel laminae.

SITE 1032 HOLE A CORE 3R CORED 203.7 - 213.3 mbsf

Meter	Graphic Lith.	Section	Age	Structure	Disturb.	Sample	Description
1		1	Quaternary	— — ● — —	×××× ×××× ×××× ×××× ××××	PP S S S IW	CLAYEY SILT to SILTY CLAY and SILT Major Lithology: Light olive gray CLAYEY SILT to SILTY CLAY with silt laminae. Minor Lithology: Thin beds of SILT with planar laminae.

Previous Chapter

Table of Contents

Next Chapter

SITE 1032 HOLE A CORE 4R CORED 213.3 - 222.9 mbsf

Meter	Graphic Lith.	Section	Age	Structure	Disturb.	Sample	Description
-		CC					CLAYEY SILT to SILTY CLAY Major Lithology: Greenish gray SILTY CLAY to CLAYEY SILT. Pyrite nodule in Core Catcher, 12 cm.

SITE 1032 HOLE A CORE 5R CORED 222.9 - 232.5 mbsf

Meter	Graphic Lith.	Section	Age	Structure	Disturb.	Sample	Description
1		1	Quaternary			PP	CLAYEY SILT to SILTY CLAY and SILT to SANDY SILT Major Lithology: Light olive gray to greenish gray and yellowish gray SILTY CLAY to CLAYEY SILT with local silt laminae and bioturbation. Lighter colored intervals contain higher concentrations of calcareous nannofossils.
2		2				PP	Minor Lithology: Thin beds of SILT and SANDY SILT. Generally with sharp bases, plane parallel laminae, and gradational tops.
3		3				IW	
4		3				PP	General Description: Pyrite nodules in Section 1, 37 cm and 67 cm, and Section 2, 111 cm.
5		4				S	
		4				S	
		4				PP	
		4				S	
		4				S	
		CC					S S

SITE 1032 HOLE A CORE 6R CORED 232.5 - 242.1 mbsf

Meter	Graphic Lith.	Section	Age	Structure	Disturb.	Sample	Description
1		1	Quaternary		XXXXXX	PP	CLAYEY SILT to SILTY CLAY and SILT to SANDY SILT Major Lithology: Light olive gray to greenish gray SILTY CLAY to CLAYEY SILT. Lighter colored intervals enriched in calcareous nannofossils. Local bioturbation, silty laminae, and pyrite nodules. Minor Lithology: Thin interbeds of SILT to SANDY SILT. Generally with sharp bases and plane-parallel laminae.
2						PP	
3						IW	
4						S	
		3				PP	
		4				IW	

SITE 1032 HOLE A CORE 7R CORED 242.1 - 251.7 mbsf

Meter	Graphic Lith.	Section	Age	Structure	Disturb.	Sample	Description
1		1	Quaternary		XXXXXX	PP	CLAYEY SILT to SILTY CLAY and SANDY SILT to SILT Major Lithology: Medium gray to light gray SILTY CLAY to CLAYEY SILT. Lighter colored intervals enriched in calcareous nannofossils. Minor bioturbation. Minor Lithology: Medium gray SANDY SILT to SILT with sharp bases, normal size grading, plane-parallel laminae, ripple cross-laminae, wavy laminae, and convolute laminae.
2						S	
3						PP	
4						S	
		3				IW	
		CC				PP	

SITE 1032 HOLE A CORE 8R CORED 251.7 - 261.4 mbsf

Meter	Graphic Lith.	Section	Age	Structure	Disturb.	Sample	Description
1		1	Quaternary		XXXX	PP S WR	CLAYEY SILT to SILTY CLAY and SANDY SILT to SILT Major Lithology: Medium gray SILTY CLAY to CLAYEY SILT with local color bands and bioturbation.
2		2			XXXX	PP	Minor Lithology: Medium gray SANDY SILT to SILT with sharp bases, normal size grading, and plane-parallel laminae.
3		3			XXXX	IW S	
		CC			XXXX	PP	

SITE 1032 HOLE A CORE 9R CORED 261.4 - 271.0 mbsf

Meter	Graphic Lith.	Section	Age	Structure	Disturb.	Sample	Description
		CC			X	S	CLAYEY SILT to SILTY CLAY Major Lithology: Medium gray SILTY CLAY to CLAYEY SILT.

SITE 1032 HOLE A CORE 10R CORED 270.0 - 280.6 mbsf

Meter	Graphic Lith.	Section	Age	Structure	Disturb.	Sample	Description
1		1	Quaternary		XXXXXX	IW	<p>CLAYEY SILT to SILTY CLAY and SILT</p> <p>Major Lithology: Light olive gray to medium gray SILTY CLAY to CLAYEY SILT. Intervals with plane-parallel laminae are slightly coarser.</p> <p>Minor Lithology: Light olive gray SILT, with sharp bases in Section 1, 101 cm, 111 cm, and 147 cm. Internal structures include wavy laminae, ripple cross-laminae, and plane parallel laminae.</p>
1		1			XXXXXX	PP S	
2		2			XXXXXX	PP	
3		3			XXXXXX	IW WR	
3		3			XXXXXX	PP	
4		4			XXXXXX	IW	
5		4			XXXXXX	PP IW S	
		CC			XXXXXX		



SITE 1032 HOLE A CORE 11R CORED 280.6 - 290.2 mbsf

Meter	Graphic Lith.	Section	Age	Structure	Disturb.	Sample	Description
1		1	Quaternary	~>>>	X	S	<p>CLAYEY SILT to SILTY CLAY</p> <p>Major Lithology: Medium olive gray to greenish gray, yellowish gray, dark gray, and moderate yellowish brown SILTY CLAY to CLAYEY SILT. Mottled by bioturbation, with local dark green color bands and <i>Zoophycos</i>. Lighter colored intervals enriched in calcareous nannofossils. Color variations are pronounced in Section 4 and Core Catcher.</p>
				~>>	X	PP	
				~>>	X	IW	
				~>>	X	WR	
2		2		~>>	X	S	
				~>>>	X	PP	
3				~>>>	X	IW	
				~>>	X		
4		3		~>>	X	PP	
				~>>	X	IW	
5		4	~>>>	X	PP		
			~>>	X	S		
		CC	~>>	X	S		



168-1032A-12R-01

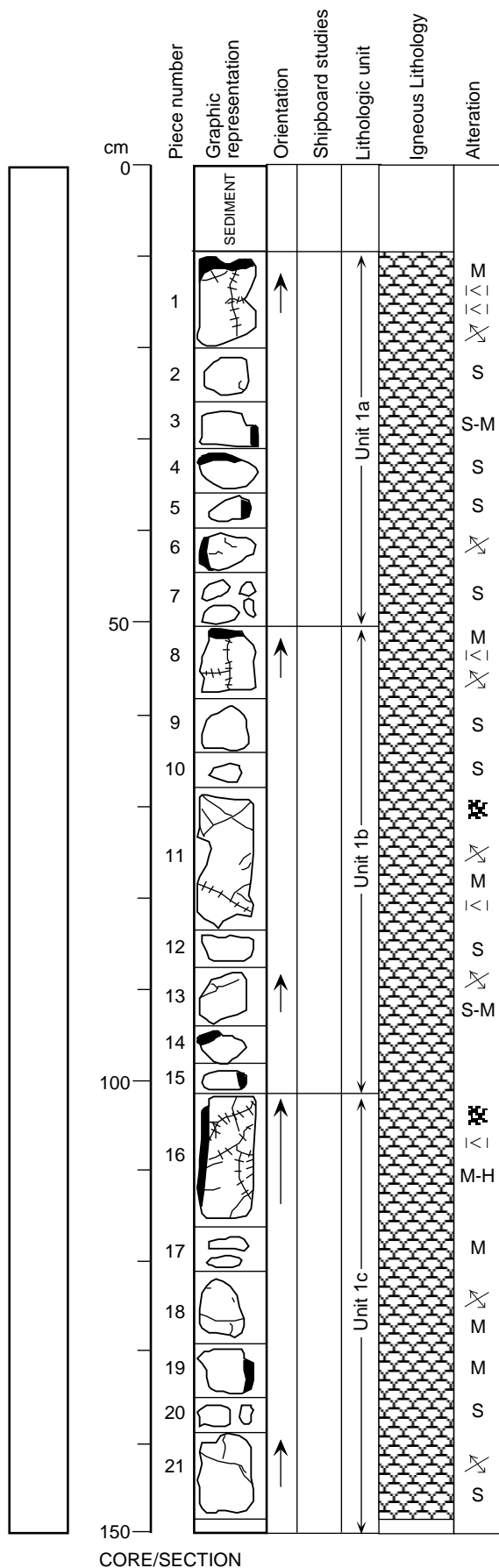

UNIT 1a-c: APHYRIC BASALT

PIECES 1-21

CONTACTS: Subunits defined by the presence of chilled margins on oriented pieces (pieces 1, 8 and 16).

PHENOCRYSTS: <1% plagioclase (≤4mm) and olivine (≤2mm) phenocrysts and rare pyroxene phenocrysts (≤1mm).

GROUNDMASS: Aphanitic cryptocrystalline to microcrystalline. From variolitic (pieces with glass margins) to intersertal. Highly crystalline band (mainly plagioclase laths and skeletal crystals) sub-parallel to the glassy margin is present on piece 1.

VESICLES: <1%, ≤1 mm diameter (ave 0.5). The following fillings were observed almost in all pieces: a) celadonite ± iddingsite ± saponite; b) saponite ± carbonate; c) carbonate; d) saponite.

COLOR: Pale to medium gray; 3.6PB 1.9/0.4 to 1.9PB 2.5/0.3

STRUCTURE: Pillow basalt.

ALTERATION: Moderate to locally slight; preferentially located around vein networks, fractures and in alteration haloes. Alteration haloes in pieces 2 (6mm wide, dark green rimmed by orange halo < 1mm), 11 (8mm, dark green; around vein network), 18 (4mm), 20 (5mm). Blue clay patch (4mm wide) on glass rim of piece 16. Millimetric to centrimetric orange and greenish clay patches on external surfaces. Bright green clay clot (celadonite?) on piece 19.

VEINS/FRACTURES: Piece 1: bifurcating vein rimmed by bright green clay ± iddingsite and filled by anhedral to fibrous carbonate crystals in the center. Piece 8: the piece is fractured along a carbonate ± pale green clay vein. Piece 11: vein network with veins (up to 0.5 mm) filled by dark to bright green clay ± iddingsite, cut by later carbonate veins and veinlets. Vein (up to 1mm wide) filled by fibrous to anhedral carbonate crystals ± pale green clay. Piece 16: vein network with veins (up to 1.3 mm wide) filled by dark to bright green clay

ADDITIONAL COMMENTS: Glassy margins on pieces 1, 3-6, 8 14-16, 19.

CORE/SECTION

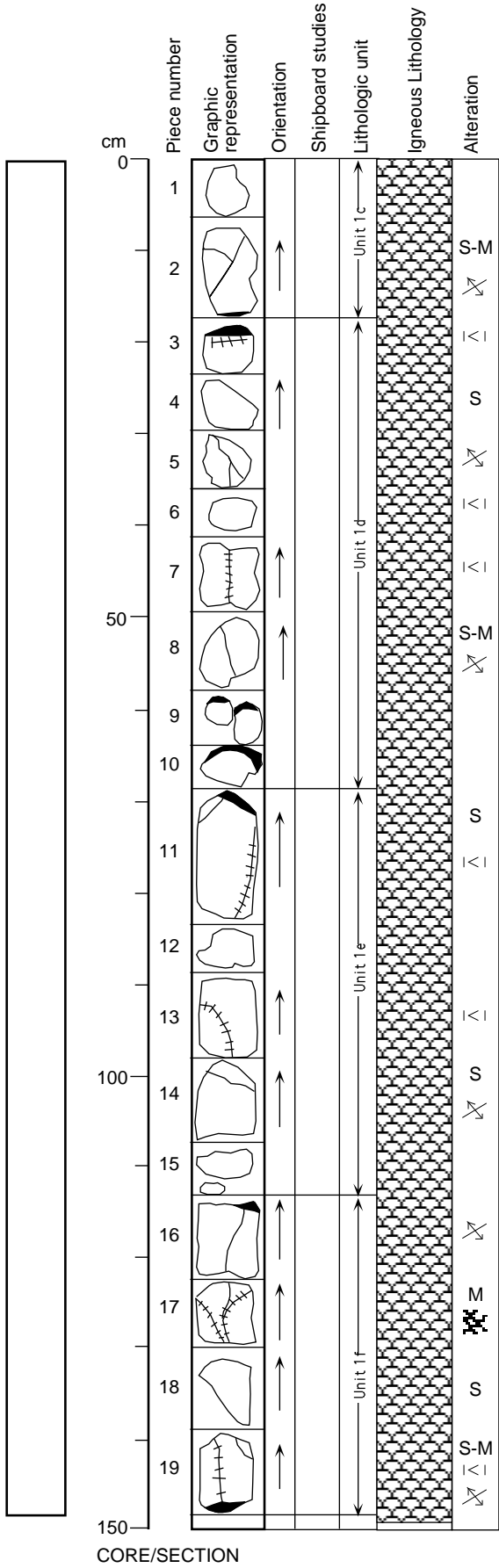

UNIT 1c-f: APHYRIC BASALT

PIECES 1-19

CONTACTS: Subunits defined by the presence of chilled margins on oriented pieces 2, 11, 16 and 19.

PHENOCRYSTS: ≤1% plagioclase laths up to 1mm-long and rare olivine (≤2mm) phenocrysts completely altered by clay.

GROUNDMASS: Aphanitic cryptocrystalline to microcrystalline. From variolitic (pieces with glass margins) to intersertal.

VESICLES: <1%, ≤1 mm diameter (ave 0.5). Completely filled by green clays.

COLOR: Pale to medium gray; 4.4 PB 2.1/0.3 to 4.9 PB 2.5/0.2

STRUCTURE: Pillow basalt.

ALTERATION: Moderate to locally slight; preferentially located around vein networks, fractures and in alteration haloes. Clay alteration halo around veins in pieces 7 and 13. Clay alteration halo around the top part of piece 18. Interstitial patches of green clay in piece 10.

VEINS/FRACTURES: Carbonate veins in piece 17. Green clay veins in pieces 3, 6, 7, 11, 13, 17 and 19.

ADDITIONAL COMMENTS: Glassy margins on pieces 2, 3, 9-11, 16 and 19.

CORE/SECTION

168-1032A-12R-03

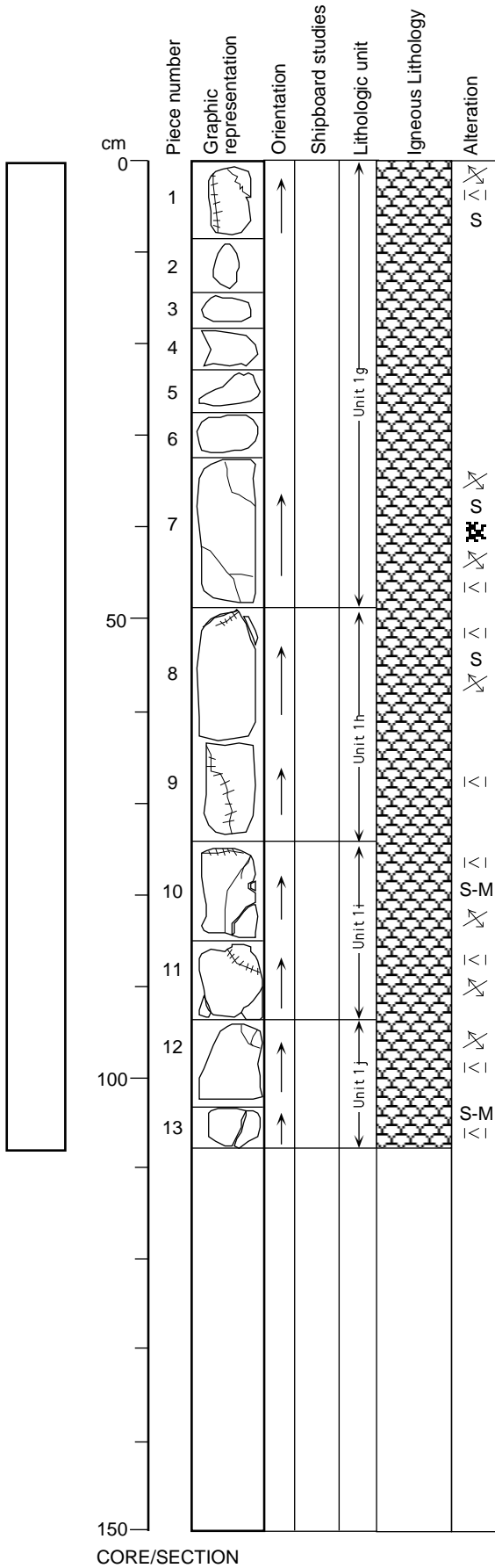

UNIT 1g-j: APHYRIC BASALT

PIECES: 1-13

CONTACTS: Subunits defined by the presence of chilled margins on oriented pieces 8, 10 and 12.

PHENOCRYSTS: ≤1% elongate plagioclase laths up to 1mm-long and rare olivine (≤2mm) phenocrysts completely altered to clay.

GROUNDMASS: Aphanitic cryptocrystalline to microcrystalline. Commonly, grain size variations are related to each quenched margin.

VESICLES: <1%, ≤1 mm diameter (ave 0.5). Completely filled by green clays.

COLOR: Pale to medium gray; 3.8 PB 2.1/0.4 to 5.2 PB 1.8/0.3

STRUCTURE: Pillow basalt.

ALTERATION: Moderate to locally slight; preferentially located around vein networks, fractures and in alteration haloes. Clay alteration halo around veins in pieces 1, 7 and 10. Alteration haloes up to 5mm-thick on each side of veins. Interstitial patches of green clay in piece 13.

VEINS/FRACTURES: Carbonate veins in piece 7. Green clay veins in pieces 1, 7, and 8-12. Orange clay vein in piece 13.

ADDITIONAL COMMENTS: Glassy margins on pieces 8, 10 and 12.

Quenched margin (but no glass fresh or altered) distinguished by grain size variations at the bottom of pieces 7 and 9.

CORE/SECTION

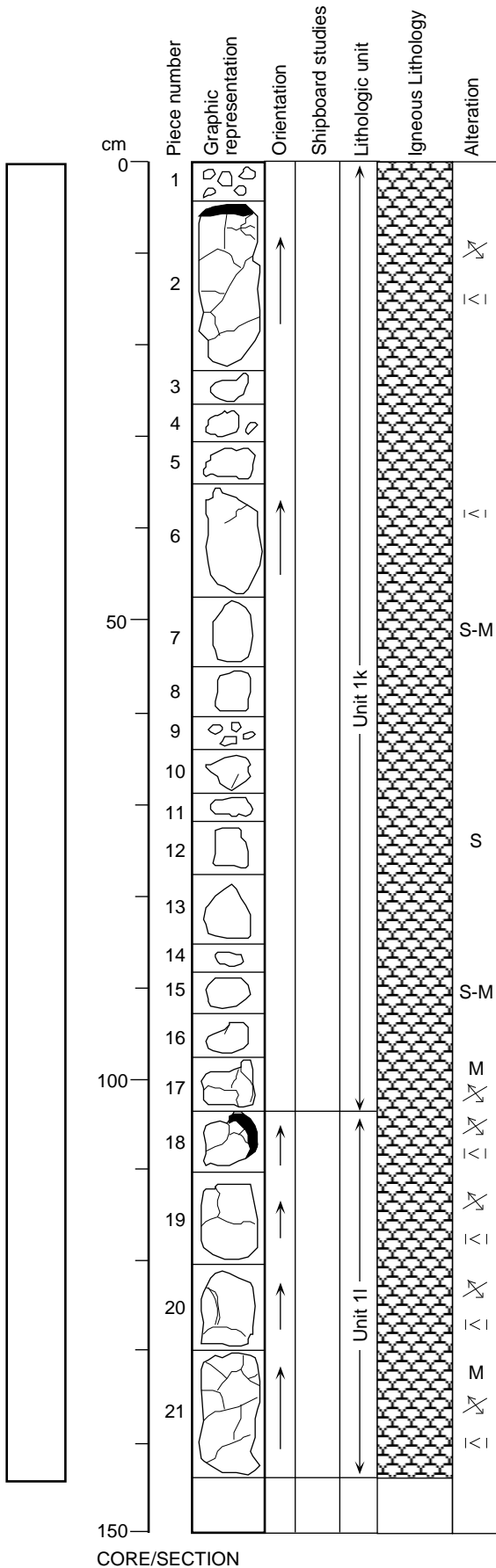

UNIT 1k-l: APHYRIC BASALT

PIECES 1-21

CONTACTS: Subunits defined by the presence of chilled margins on oriented pieces (2, 18).

PHENOCRYSTS: Trace olivine ($\leq 2\text{mm}$) (completely replaced by dark green clay) and plagioclase phenocrysts ($\leq 3\text{mm}$).

GROUNDMASS: Aphanitic cryptocrystalline to microcrystalline. From variolitic (pieces with glass margins) to intersertal.

VESICLES: $< 1\%$, $\leq 1\text{ mm}$ diameter (ave 0.5). The following fillings were observed in almost all pieces: a) celadonite \pm iddingsite \pm saponite; b) saponite \pm carbonate; c) carbonate; d) saponite; e) iddingsite.

COLOR: Pale to medium gray; 3.5PB 2.3/0.3 to 3.4PB 1.6/0.3

STRUCTURE: Pillow basalt.

ALTERATION: Moderate to locally slight; preferentially located around vein networks, fractures and in alteration haloes. Dark grey haloes ($\leq 1\text{cm}$) around veins and fractures in pieces 2, 17-21, and along the borders of pieces 7 and 15. Clay minerals (pale blue, greenish, dark green, orange) are present in all pieces as patches on external surfaces and as coatings on fractures. Centimetric pyrite patches on external surface of piece 15. The glassy rim on piece 18 is partially palagonitized. Disseminated sulfide grains ($\ll 1\text{mm}$) around one clay veinlet in piece 17.

VEINS/FRACTURES: Piece 1: vein (up to 1 mm wide) rimmed by whitish to pale green clay mineral \pm iddingsite and filled by complex mixture of dark to bright green clay minerals \pm carbonate \pm iddingsite. Dark green clay veins and veinlets on pieces 2, 10, 17-19 and 21. Iddingsite \pm dark green clay mineral veins ($\leq 1\text{mm}$) in piece 6.

ADDITIONAL COMMENTS: Glassy margins on pieces 2 and 18.

Pieces 2, 17 and 21 are mainly fractured along green clay \pm carbonate veins. Pieces 1 are mixed fragments of sediment and basalt.

168-1032A-13R-02

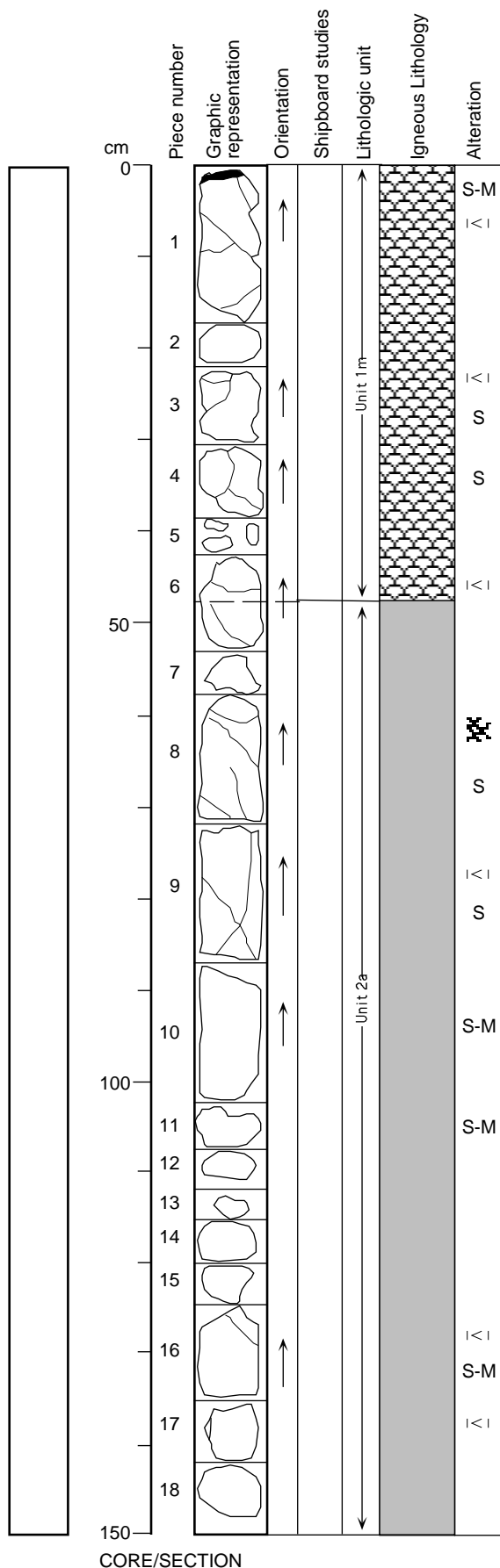

UNIT 1m: APHYRIC BASALT

PIECES 1-6

CONTACTS: Subunits defined by the presence of chilled margin on oriented piece 1.

PHENOCRYSTS: Trace olivine ($\leq 2\text{mm}$) (completely replaced by dark green clay) and trace plagioclase phenocrysts ($\leq 1\text{mm}$).

GROUNDMASS: Aphanitic cryptocrystalline to microcrystalline. Variolitic to sub-variolitic texture.

VESICLES: $< 1\%$, $\leq 1\text{ mm}$ diameter (ave 0.5).

COLOR: Pale to medium gray; 4.6PB 3.0/0.3 to 9.6PB 2.2/0.2

STRUCTURE: Pillow basalt.

ALTERATION: Slight; confined to veins. No alteration haloes.

VEINS/FRACTURES: Green to yellow clay veins and veinlets on pieces 1, 3 and top of 6.

ADDITIONAL COMMENTS: Chilled margin with glass in piece 1.

UNIT 2a: APHYRIC BASALT

PIECES 6-18

CONTACTS: Unit defined by sharp igneous contact in the middle of oriented piece 6.

PHENOCRYSTS: Rare olivine ($\leq 2\text{mm}$) (completely replaced by dark green clay) and rare plagioclase phenocrysts ($\leq 1\text{mm}$).

GROUNDMASS: Aphanitic microcrystalline. Intergranular texture.

VESICLES: Variable from 1 to 3%, mostly $\leq 1\text{mm}$ in diameter. Pieces 10 and 11 have 3% vesicles of variable size (< 0.1 up to 2mm in diameter) and partly filled by: a) green clay; b) green clay + pyrite; c) green clay \pm pyrite + carbonate; d) carbonate.

COLOR: Pale to medium gray; 8.8PB 2.5/0.1 to 4.2PB 2.0/0.3

STRUCTURE: Massive basalt or core of large pillow basalt.

ALTERATION: Slight to moderate, mostly as vesicle infills and small ($\leq 1\text{mm}$) interstitial clay patches. Small iddingsite haloes in pieces 6 (bottom), 7, 8 (top) and 11.

VEINS/FRACTURES: Carbonate veins in pieces 8, 9, 16 and 17. Green to yellow clay veins and veinlets on pieces 6 and 8. Amount of clay veins is lower than for unit 1 and carbonate veining is higher.

ADDITIONAL COMMENTS: This unit has no heterogenous grain size variations like the previous sub-units. Instead it is characterized by a homogeneous and steady increase in grain size from the contacts towards the interior of the unit.

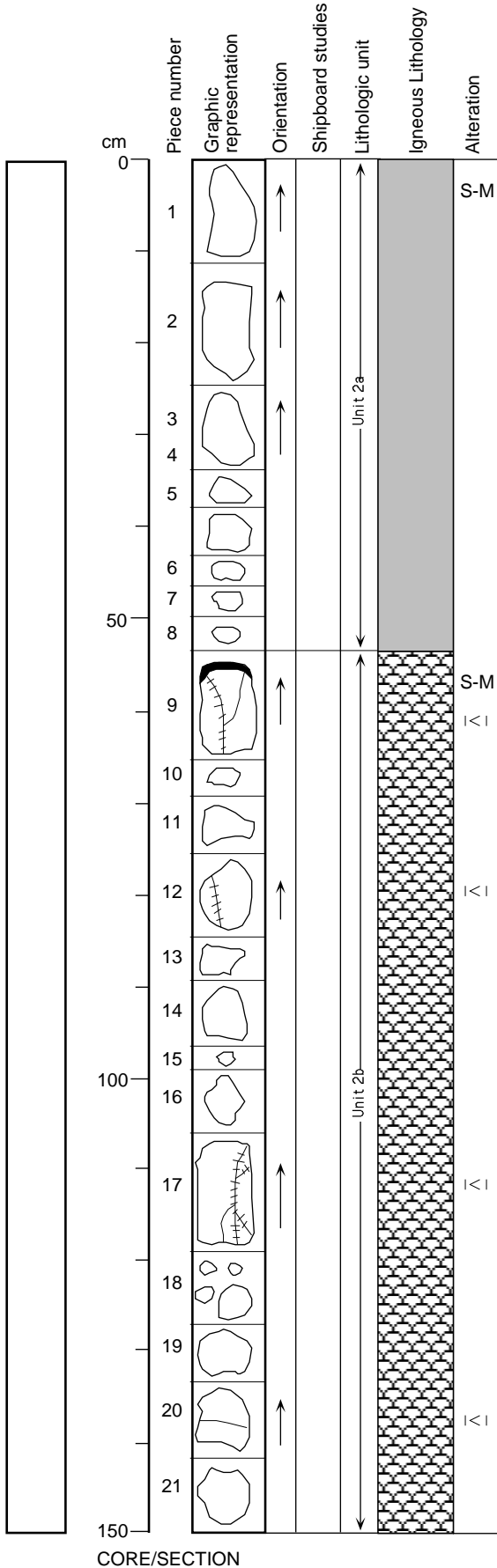

UNIT 2a: APHYRIC BASALT

PIECES 1-8

CONTACTS: None.

PHENOCRYSTS: Rare olivine(?) completely pseudomorphed by a mixture of green clay and white carbonate, 1-2mm across.

GROUNDMASS: Microcrystalline, intersertal texture defined by plagioclase microlites.

VESICLES: <1%, < 0.5mm.

COLOR: Gray, 8.0B 2.4/0.2 (piece 1), 2.5PB 1.5/0.3 (piece 2)

STRUCTURE: Massive basalt.

ALTERATION: Most alteration confined to vesicle fillings, the mineralogy of which is generally zoned according to the location with respect to alteration haloes. A typical halo sequence consists of a 2-3mm outer zone with orange-yellow and light green vesicle fills, followed by a 5mm zone with dark green vesicle fills. The internal gray rock may have pale green clay filling vesicles, ± white carbonate amygdules. The best alteration haloes are developed in pieces 2 and 5.

VEINS/FRACTURES: Hairline fractures contain iddingsite and green clay within some haloes. The rock surfaces contain green clay plus white carbonate as partial coatings, <1mm thick.

ADDITIONAL COMMENTS: Pieces 6-8 are finer grained and cryptocrystalline, more similar to the next unit.

UNIT 2b: APHYRIC BASALT

PIECES 9-21

CONTACTS: Subunits defined by the presence of chilled margin on oriented piece 9.

PHENOCRYSTS: Rare plagioclase, up to 0.6mm long laths.

GROUNDMASS: Cryptocrystalline to microcrystalline, including various quench textures (e.g., variolitic, subvariolitic).

VESICLES: < 1%, < 0.75mm.

COLOR: Gray, 5.2PB 2.5/0.3 (piece 9), 2.2PB 2.1/0.3 (piece 12)

STRUCTURE: Pillow basalt.

ALTERATION: Vesicle fillings and groundmass replacement by minerals (yellow-orange, orange, light and dark green clays, white carbonate) is linked to the distribution of alteration haloes. Distinct haloes, 5-10mm, in pieces 9, 12, 13, 15, 17, 19 and 20. Piece 13 has cm-scale cavities coated with tiny green clay balls. The halo in piece 19 has a 0.5-mm bright orange zone just inside the 5mm yellow-orange plus green zone. The haloes in piece 20 are asymmetric about the veinlets (present on one side only in places).

VEINS/FRACTURES: Veinlets contain orange-yellow ± bright green clay, dark green clay, dark green clay + sulfide (piece 9). Clay veins in pieces 12 and 20 have 5mm dark haloes.

ADDITIONAL COMMENTS: Pieces 10-13 are coarser-grained (microcrystalline texture) than the rest.

CORE/SECTION

168-1032A-13R-04

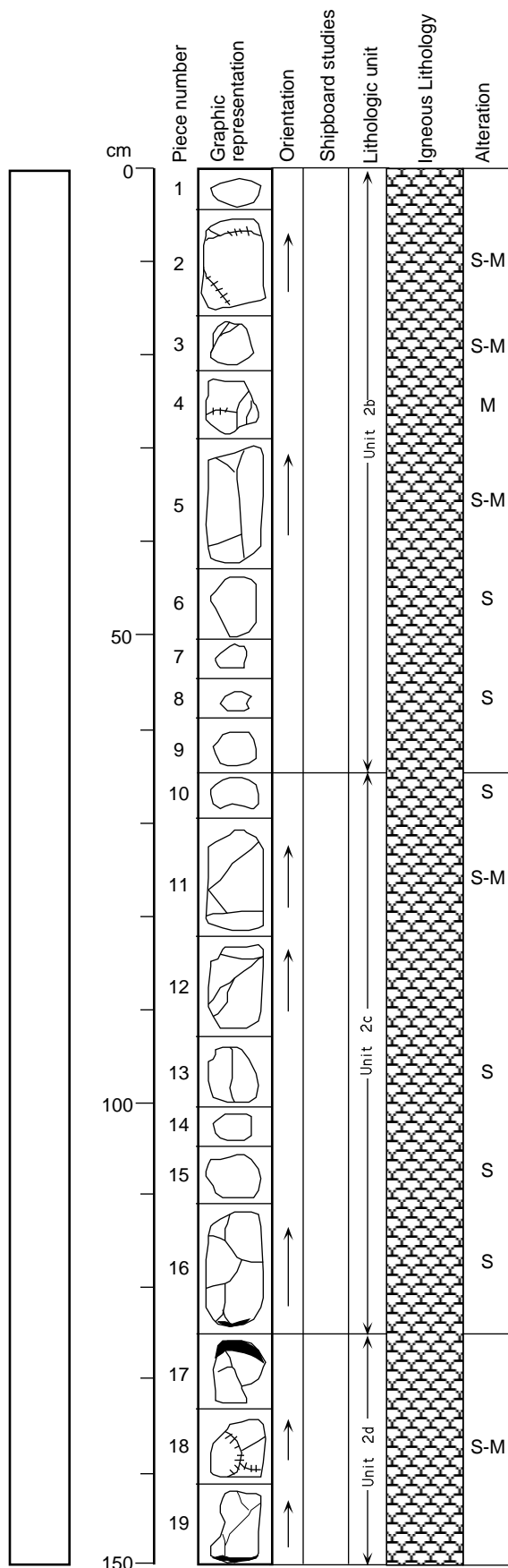

CORE/SECTION

UNIT 2b: APHYRIC BASALT

PIECES 1-9

CONTACTS: None.
PHENOCRYSTS: Trace plagioclase laths, euhedral, ≤ 2.5 mm to no apparent phenocrysts.
GROUNDMASS: Varies from microcrystalline to fine grained (pieces 1-3) to microcrystalline to cryptocrystalline (pieces 4-9). Intergranular to intersertal texture; predominantly intersertal at base of subsection.
VESICLES: Round to irregular, 0.75-1mm, trace to $< 1\%$. In interior of rock, vesicles are empty or filled with white carbonate \pm green saponite (pieces 6-9). In alteration haloes, vesicles are filled by dark green saponite \pm bright green celadonite \pm orange iddingsite.
COLOR: Medium to light gray; 8.4B 4.3/0.1 to 2.2G 4.6/0.2
STRUCTURE: Pillow basalts.
ALTERATION: All veins have alteration haloes varying from 2-20mm. In haloes vesicles are filled by orange, dark green, bright green and yellow clays. Pieces 3&4 have haloes with strong iddingsite bands (2-4mm) followed by pyrite rich bands (2-3mm).
VEINS/FRACTURES: Veins in pieces 2 (iddingsite, ≤ 1 mm; celadonite ≤ 0.5 m); 3 (0.5mm celadonite + iddingsite \pm saponite), 4 (0.5-1.5mm saponite; 1.5mm celadonite + iddingsite; 1mm iddingsite + hematite + saponite), 5 (0.5mm iddingsite + saponite), 6 (0.2-1mm saponite + celadonite + iddingsite \pm carbonate). All veins have alteration haloes.

UNIT 2c-d: APHYRIC BASALT

PIECES 10-19

CONTACTS: Unit 2b and 2c distinguished by change in grain size and texture. Units 2c and 2d separated by chilled margins.
PHENOCRYSTS: Trace plagioclase laths ≤ 2 mm, euhedral; trace olivine, euhedral, ≤ 1.5 mm, replaced by dark green saponite; \pm trace pyroxene, black, fresh, ≤ 0.5 mm, euhedral.
GROUNDMASS: Glassy to subvolcanic to intersertal; glassy to cryptocrystalline (\pm microcrystalline in subunit 2d).
VESICLES: ≤ 0.5 mm, sparse and round, filled by green-gray saponite to ≤ 1 mm round, sparse, filled by white carbonate in interior of rock. In subvolcanic areas, irregular cavities (1-2mm) are filled by dark green \pm yellow-green \pm orange clay.
COLOR: Light gray; subunit 2c: 0.8PB 4.2/0.2 to 2.6PB 3.9/0.3; subunit 2d: 6.2B 4.6/0.2 to 4.5BG 4.6/0.1
STRUCTURE: Pillow basalts.
ALTERATION: Slight, increasing to moderate in the alteration haloes associated with the veins and fractures. In haloes, vesicles are filled and olivine is replaced by saponite, iddingsite, celadonite \pm pyrite. Some patchy groundmass alteration.
VEINS/FRACTURES: Veins in pieces 10 (≤ 0.1 mm and 3mm, iddingsite), 11 (0.1-0.5mm, iddingsite \pm celadonite + saponite), 13 (0.1mm, iddingsite + saponite), 15 (< 0.1 mm, celadonite \pm pyrite), 16 (< 0.1 mm saponite \pm pyrite); 17-19 (hairline to 1mm, saponite \pm celadonite \pm iddingsite).
ADDITIONAL COMMENTS: Glass rims on pieces 17 and 19.

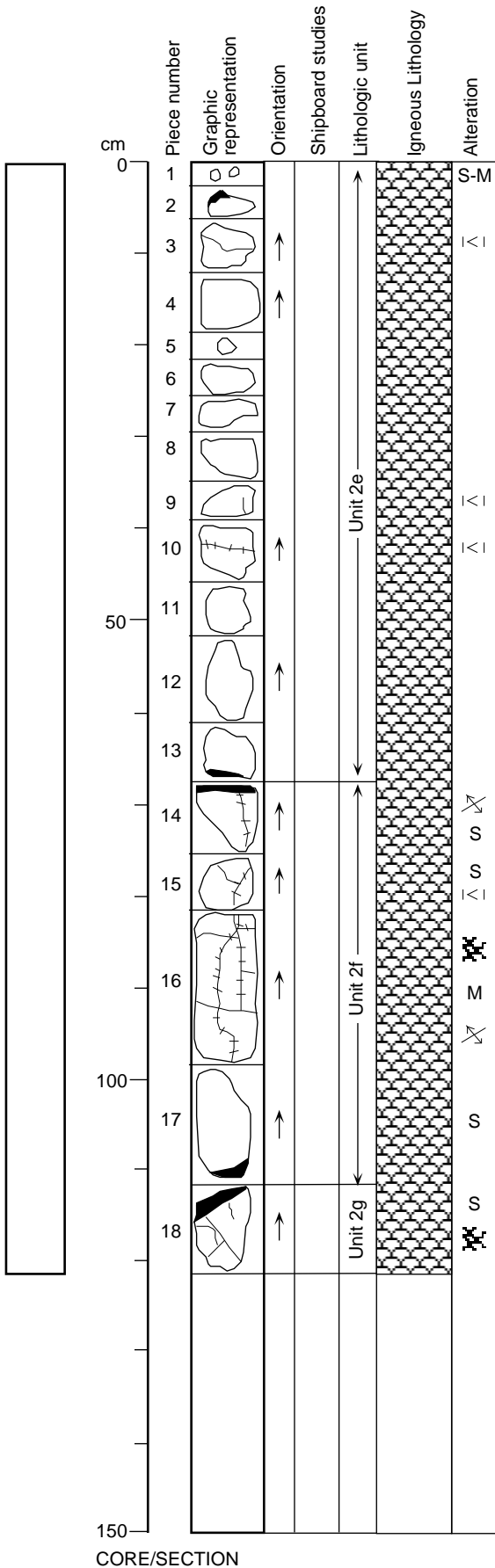

UNIT 2e: APHYRIC BASALT

PIECES 1-13

CONTACTS: Contacts defined by glass margins on oriented piece 19 from Core 13R-4, and at the top of oriented piece 14.

PHENOCRYSTS: Rare olivine (≤ 2.5 mm, completely pseudomorphed by green clay and white carbonate).

GROUNDMASS: Variable from cryptocrystalline (variolitic and subvariolitic) to microcrystalline (particularly pieces 6-11).

VESICLES: $\leq 1\%$, ≤ 0.8 mm; mostly filled by secondary minerals.

COLOR: 1.1PB 1.9/0.1 (piece 2), 2.6PB 1.9/0.1 (piece 3), 9.6B 1.6/0.1 (piece 11)

STRUCTURE: Pillow basalt.

ALTERATION: Slight to moderate; primarily vesicle fillings (clays of various colors, carbonate, pyrite) and limited groundmass replacement. Alteration haloes common, defined by yellow-orange clay, bright green clay, and dark green clay vesicle fillings, with similar varicolored clays in veinlets. Haloes occur at rock edges (2-5mm wide) and along some fractures. No halo on the carbonate vein in piece 10. Inside of alteration haloes, the gray rock is fresh except for olivine pseudomorphs and vesicles filled by green clay or carbonate \pm pyrite.

VEINS/FRACTURES: Fibrous carbonate-clay veins (1mm) in piece 10 and on the surface of piece 8. Oxidation (yellow-orange clays) veinlets in pieces 7 and 9. In piece 7, the mineralogy varies along strike as the vein passes from the halo into the rock: orange-yellow clay, then light green clay, dark green clay + pyrite, and finally carbonate.

ADDITIONAL COMMENTS: Glass rim on unoriented piece 2.

UNIT 2f-g: APHYRIC BASALT

PIECES 14-18

CONTACTS: Subunits defined by glass margins on oriented pieces 14, 17 and 18.

PHENOCRYSTS: Rare olivine (≤ 1 mm, completely pseudomorphed by green clay and white carbonate) and rare plagioclase (≤ 2 mm).

GROUNDMASS: Cryptocrystalline, with quench textures varying from glassy to variolitic and subvariolitic.

VESICLES: $\leq 1\%$, ≤ 0.5 mm; mostly filled by secondary minerals.

COLOR: 4.2PB 1.8/0.1 (piece 14), 5.7PB 1.8/0.3 (piece 17), 4.9PB 1.7/0.4 (piece 18)

STRUCTURE: Pillow basalt.

ALTERATION: Slight to moderate; primarily vesicle fillings (clays of various colors, carbonate, pyrite) and groundmass replacement (most prevalent in piece 16). Alteration haloes are present only in piece 16: the other pieces have none or very minor development of oxidative alteration near the edge.

VEINS/FRACTURES: Clay veins with oxidative (orange-yellow and light green) minerals in piece 16 and surface of piece 17. That in piece 16 has a 6-8mm halo. Carbonate + clay veins in pieces 14 (0.75mm), 15 (0.5mm), 16 (1mm) and 17 (2mm). Veinlets (≤ 0.5 mm) in piece 18 in the glass margin are layered with clear, light blue and white layers (zeolite and clay?).

ADDITIONAL COMMENTS:

168-1032A-14R-02

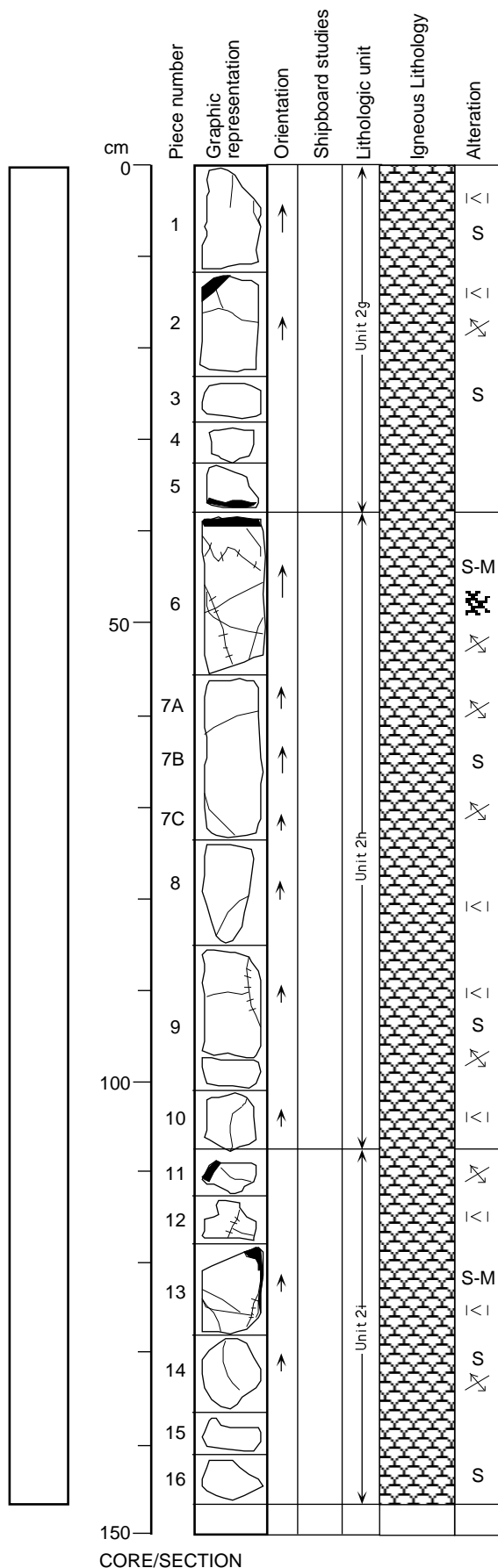

UNIT 2g and 2h: APHYRIC BASALT

PIECES 1-5 (2g) and 6-10 (2h)

CONTACTS: Subunits defined by the presence of glassy chilled margins on pieces 5 and 6.

PHENOCRYSTS: Trace amounts of plagioclase (1-2mm, euhedral) and olivine (0.5-2mm, euhedral, replaced by dark green clay [saponite] ± carbonate). Piece 2 has no apparent phenocrysts.

GROUNDMASS: Predominantly cryptocrystalline (± microcrystalline in piece 2); texture varies from glassy (pieces 2, 5 and 6) to variolitic, subvariolitic and intersertal.

VESICLES: ≤0.5mm, <1% to trace, filled by blue-gray to gray-green clay (saponite) ± carbonate. Irregular cavities (1-2mm) in the variolitic zones, are filled by the same clay mineral.

COLOR: Medium to light grey; unit 2g: 1.6PB 3.8/0.3 to 5.5B 4.0/0.2; unit 2h: 5.8B 3.5/0.1 to 8.3BG 3.9/0.1

STRUCTURE: Pillow basalts.

ALTERATION: Slight; limited to the replacement of olivine and filling of vesicles by blue-gray clay. Minor alteration haloes on some pieces associated with veins and fractures.

VEINS/FRACTURES: Veins on pieces 1 (0.1-0.2mm, green saponite + orange iddingsite ± pyrite), 2 (as piece 1, but with a 3mm orange halo), 7 (pieces a, b and c are separated by carbonate + green saponite veins, <0.5mm), 8 (≤0.1mm, carbonate + pyrite), 9 (≤2mm, orange iddingsite + green saponite + carbonate ± pyrite, with 4mm yellow alteration halo), and 10 (0.1mm orange iddingsite + carbonate ± pyrite, with 5-12mm green halo).

ADDITIONAL COMMENTS: Glass on pieces 2 and 5.

UNIT 2i: APHYRIC BASALT

PIECES 11-16

CONTACTS: Subunits defined by change in texture and glass margin on piece 11.

PHENOCRYSTS: Trace amounts of plagioclase (≤1mm, euhedral), olivine (0.5-2mm, euhedral, replaced by green clay + carbonate) and black pyroxene (≤0.5mm, fresh).

GROUNDMASS: Cryptocrystalline ± microcrystalline; texture varies from glassy (pieces 11 and 13) to variolitic and subvariolitic.

VESICLES: ≤0.5mm, <2%; round to ovoid, filled by dark green clay (saponite) ± linings of pyrite. ≤1mm irregular cavities in variolitic zones are similarly filled.

COLOR: Medium to light gray; 3.3PB 3.6/0.4 to 4.1PB 3.6/0.4

STRUCTURE: Pillow basalts.

ALTERATION: Slight; patchy alteration of the groundmass. Piece 14 has a well developed alteration halo consisting of a 6-7mm green (saponite) band and a 1-2mm orange (iddingsite) band.

VEINS/FRACTURES: Hairline fractures and green to yellow clay veins in all pieces; pieces 12 and 13 have 0.5mm and 1mm fibrous carbonate veins, lined by green or yellow clay.

ADDITIONAL COMMENTS: Glass on pieces 11 and 13.

CORE/SECTION

168-1032A-14R-03

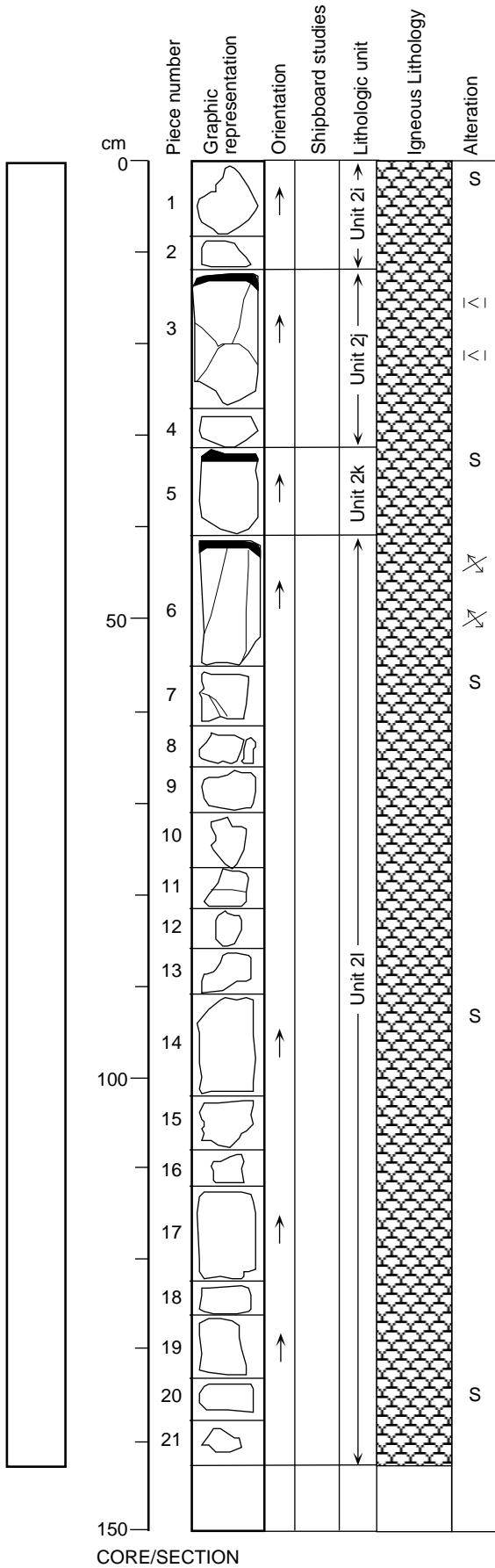

UNIT 2i-1: APHYRIC BASALT

PIECES 1-21

CONTACTS: Subunits defined by the presence of glassy chilled margins on oriented pieces 3, 5 and 6.

PHENOCRYSTS: Rare olivine ($\leq 2\text{mm}$, completely replaced by green clay and white carbonate); piece 5 contains a 2mm glomeroporphyritic clot with numerous stubby plagioclase microphenocrysts and one clinopyroxene microphenocryst.

GROUNDMASS: Varies from glassy (pieces 3, 5 and 6) to variolitic (pieces 1-6, 15, 16 and 21) to subvariolitic and microcrystalline (pieces 7-14, 17-20).

VESICLES: $< 1\%$, $\leq 0.8\text{mm}$; completely filled by secondary minerals.

COLOR: 5.0PB 1.3/0.2 (piece 1) to 3.2PB 1.5/0.3 (piece 14)

STRUCTURE: Pillow basalt.

ALTERATION: Slight; replacement of olivine by green clay and carbonate (+ iddingsite if located within an alteration halo); vesicles filled by gray-green clay (ubiquitous) or carbonate \pm pyrite (in pieces 5, 9, 13, 19 and 20). Vesicles contain iddingsite/yellowish clay or bright green clay when located within alteration (oxidation) haloes. Alteration haloes present in pieces 1 and 2 (very minor), 5 (minor), 6, 7 (4mm), 8 (4mm), 9 (10mm), 10 (8mm, weak), 11, 13 (5mm, very weak), 15 (heavily iron stained), 16 (10mm), 17 (5mm), 18 (3mm), 19 (7mm), 20 (7mm) and 21 (iron stained).

VEINS/FRACTURES: Green clay (commonly in tiny balls) and carbonate (commonly granular) for veins, $\leq 1\text{mm}$ wide, on the outer surfaces of pieces 1, 16, 17 and 19. Clay alone forms on the surfaces of pieces 11 and 15.

CORE/SECTION

168-1032A-14R-04

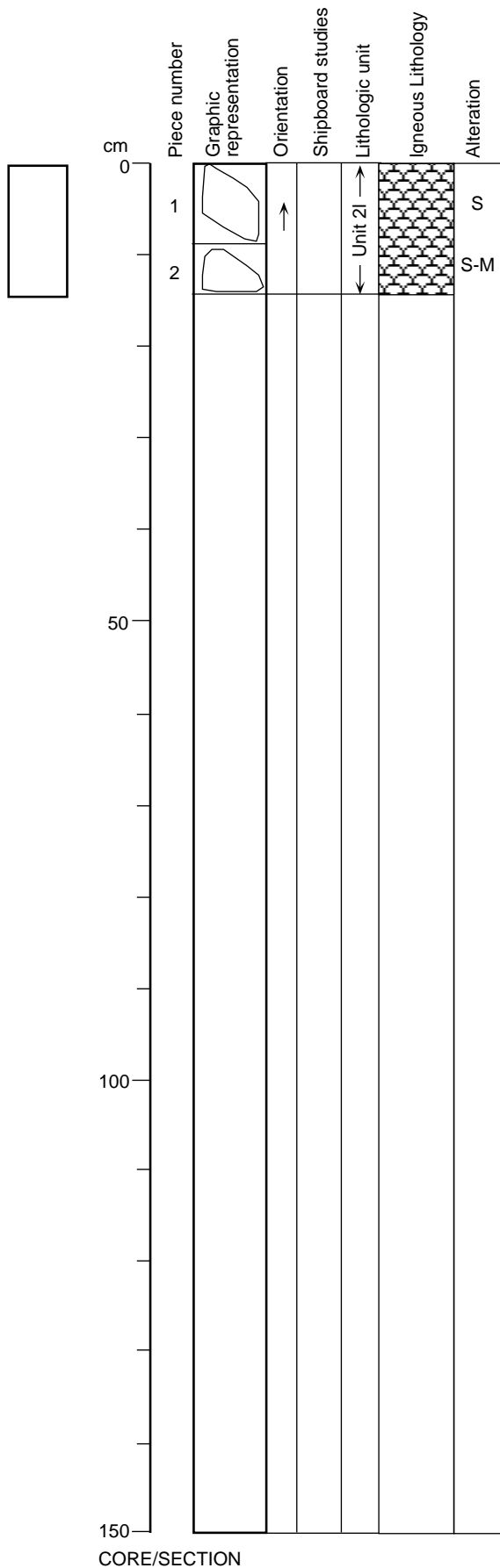

UNIT 21: APHYRIC BASALT

PIECES 1-2

CONTACTS: None.
PHENOCRYSTS: Trace amounts of plagioclase (1mm, euhedral) and olivine (≤ 2 mm, euhedral, replaced by green-gray clay [saponite] \pm carbonate.)
GROUNDMASS: Microcrystalline \pm cryptocrystalline (piece 2 only), with an intergranular to intersertal texture.
VESICLES: Trace amount, ≤ 0.4 mm, filled by gray-blue saponite clay. In the alteration halo in piece 2, the vesicles are filled by orange iddingsite.
COLOR: Medium gray; 6.2B 3.7/0.1 to 4.5GY 4.4/0.1
STRUCTURE: Pillow basalts.
ALTERATION: The base of piece 1 has a 16mm oxidation halo, consisting of orange (iddingsite) + yellow clay filling the vesicles and replacing olivine; alteration is slight. In piece 2, there is a 14mm well developed oxidation halo, consisting of a 4mm orange (iddingsite) band followed by a 10mm green (saponite) band. On the inner edge of the halo is a 1mm pyrite rich band; alteration is moderate.
VEINS/FRACTURES: Base of piece 1 is a fracture, lined by 1mm band of dark green (saponite) clay.

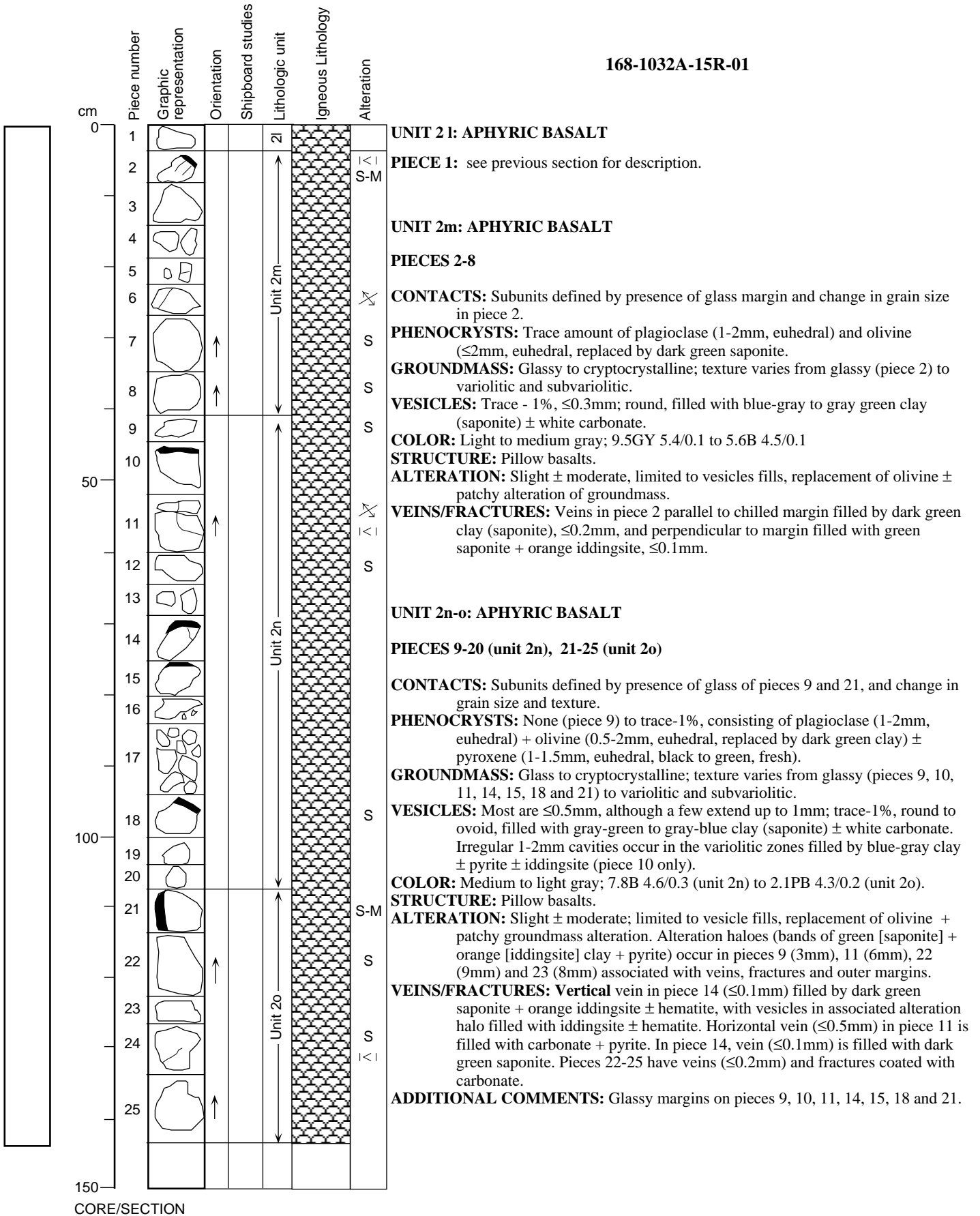

168-1032A-15R-02

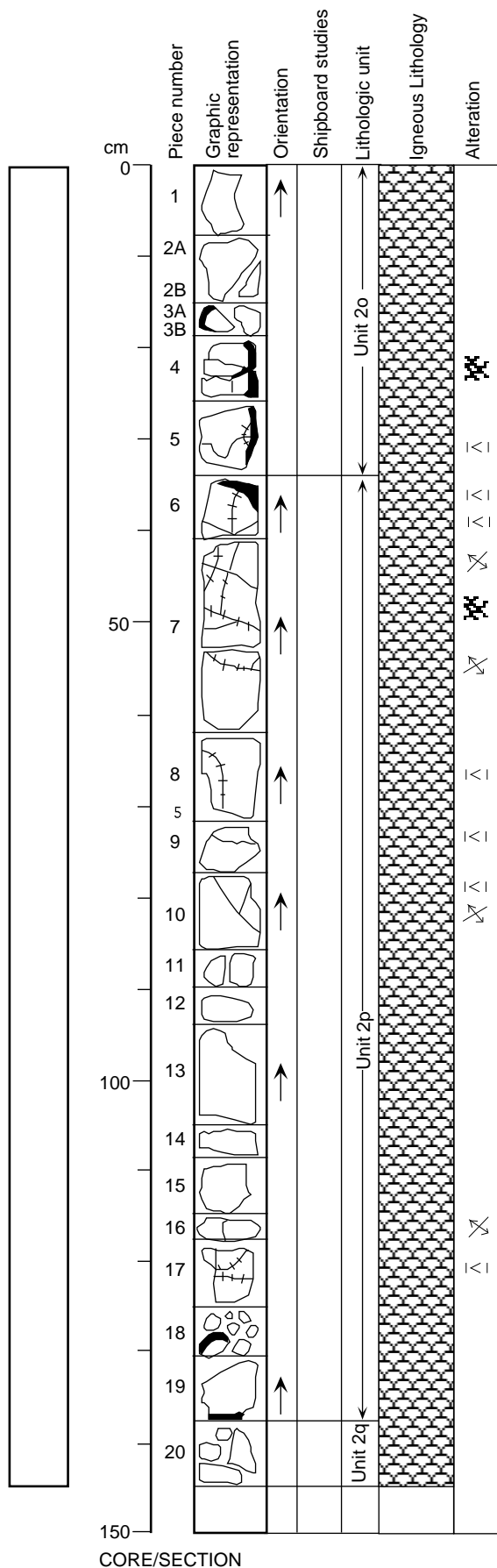

UNIT 2o-q: APHYRIC BASALT

PIECES 1-20

CONTACTS: Subunits defined by the presence of glassy chilled margins on oriented pieces 6 and 19.

PHENOCRYSTS: Rare olivine (≤ 2 mm, completely altered to green clay \pm carbonate), and rare plagioclase (≤ 2 mm, as individual crystals or clots of smaller microphenocrysts).

GROUNDMASS: Variable from glassy (pieces 3-6, 18 and 19) to subvariolithic (pieces 1-6, 14-20) to microcrystalline (pieces 7-13).

VESICLES: Rare, ≤ 0.75 mm, completely filled by secondary minerals.

COLOR: 2.7PB 1.9/0.2 (piece 8) to 6.2PB 2.0/0.2 (piece 19)

STRUCTURE: Pillow basalt.

ALTERATION: Slight; vesicle fillings and phenocryst (olivine) replacement, as well as groundmass replacement locally in alteration haloes. Vesicles commonly replaced by gray-green or dark green clay, and rarely by carbonate. In alteration haloes, vesicles may be filled by bright green clay and/or iddingsite/yellow clay. Olivine crystals are replaced by green clay + carbonate or, less commonly, green clay alone. Oxidative alteration haloes, characterized by yellow clay in the groundmass on rock edges or along veins, occur in pieces 3 (3mm along edge), 6 (2mm on each side of a bright green + yellow clay vein), 7 (4mm haloes flanking bright green + yellow clay veins which are re-opened by carbonate – veins with carbonate alone have no haloes), 8 (weak halo on a bright green + yellow clay vein), 11 and 12 (3mm haloes around both pieces), and 17 (2mm haloes on bright green + yellow clay veins). Dark haloes with or without interstitial sulfide or interstitial yellow clay near the inner edge occur in pieces 13 (10mm halo, then a 1-2mm sulfide-rich band), 16 (8mm faint dark halo), and 19 (6mm dark halo with interstitial yellow clay at the inner edge).

VEINS/FRACTURES: Light green or dark green clay veins occur on the surface or within pieces 2, 3, 9 (a 0.2mm dark green clay + pyrite, and a 0.2mm light green clay vein), 13, 16, 17 and 20. Carbonate + clay veins occur in pieces 4 (1mm), 6 (0.25mm), 7 (several, ≤ 2 mm), 8 (2mm, + pyrite), 9 (1mm, + pyrite), 10 (1mm) and 13 (on surface). Bright green + yellow clay (celadonite + iddingsite/yellow clay) veins occur in pieces 3, 4, 6 (0.75mm), 7, 8 and 17 (≤ 1 mm); these veins typically have oxidative alteration haloes. Vein networks (≤ 1 mm) in glass, in pieces 5 and 6, contain clear, pale blue and white layers, and are probably clay + zeolite.

ADDITIONAL COMMENTS:

CORE/SECTION

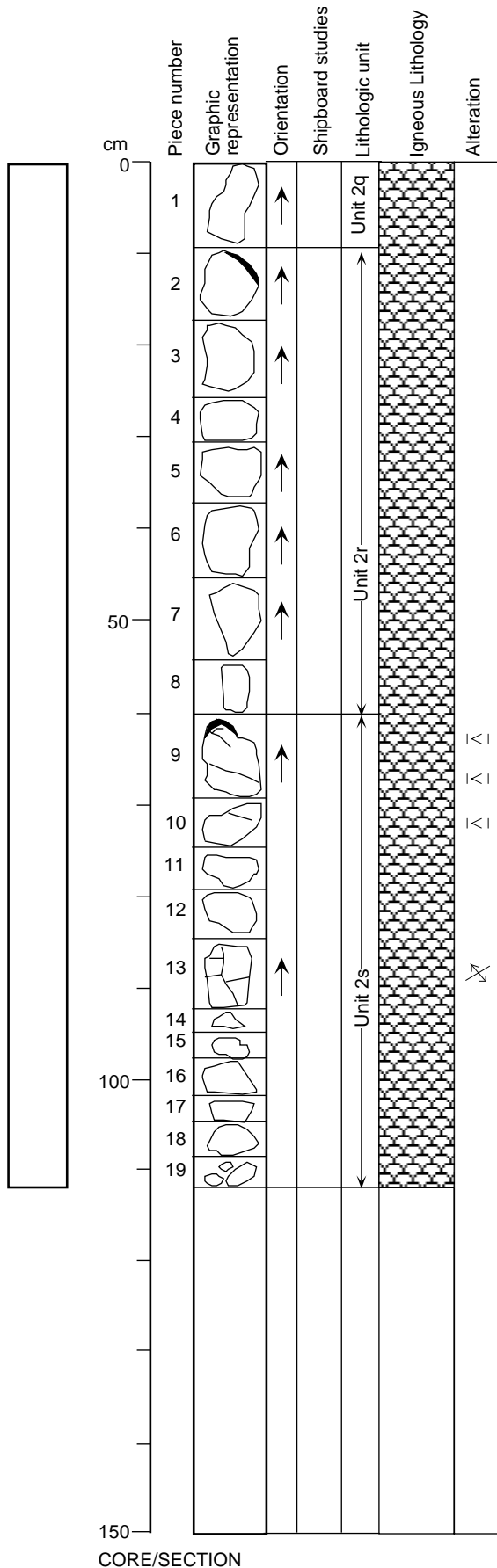

UNIT 2q: APHYRIC BASALT

PIECE 1

CONTACTS: Subunit defined by the presence of glass on piece 2 below.
PHENOCRYSTS: Trace amounts of plagioclase (≤ 1.5 mm, euhedral) and olivine (≤ 1.5 mm, euhedral, replaced by pale green clay \pm carbonate).
GROUNDMASS: Intersertal texture; microcrystalline (coarse end of unit 2q).
VESICLES: Trace-1%, ≤ 0.5 mm, filled with blue-green clay or carbonate; round.
COLOR: Medium gray; 2.5G 4.2/0.1
STRUCTURE: Pillow basalt.
ALTERATION: Slight; 10mm alteration halo (green + yellow clay with pyrite band) at base of piece.
VEINS/FRACTURES: None.

UNIT 2r: APHYRIC BASALT.

PIECES 2-8

CONTACTS: Subunit defined by chilled margin on piece 2 and change in grain size and texture.
PHENOCRYSTS: Trace amounts of plagioclase (≤ 2 mm, euhedral) + olivine (1-2mm, euhedral, replaced by dark green clay \pm carbonate) \pm pyroxene (≤ 1 mm, euhedral, black, fresh).
GROUNDMASS: Glass (piece 2) to cryptocrystalline to microcrystalline; texture varies from glassy to variolitic, subvariolitic and intersertal.
VESICLES: Trace-1%, ≤ 0.5 mm, round; filled with dark green clay or carbonate (in a band parallel to alteration haloes).
COLOR: Medium gray; 7.3GY 4.5/0.1 to 1.1G 4.4/0.1
STRUCTURE: Pillow basalts.
ALTERATION: Slight; alteration haloes of green (saponite) + yellow (iddingsite) clay followed by 1-2mm disseminated pyrite band in pieces 2 (8mm), 6 (7mm), 7 (8mm) and 8 (8mm with additional celadonite? between the green and yellow bands).
VEINS/FRACTURES: None.

UNIT 2s: APHYRIC TO SPARSELY PHYRIC PLAGIOCLASE-OLIVINE-PYROXENE BASALT

PIECES 9-19

CONTACTS: Subunit defined by change in grain size and texture.
PHENOCRYSTS: Trace amounts (piece 9 has 1-2%) of plagioclase (≤ 2 mm, euhedral) + olivine (≤ 3 mm, euhedral, replaced by dark-light green clay \pm carbonate) \pm pyroxene (≤ 1.5 mm, euhedral, black, fresh).
GROUNDMASS: Glass (piece 9) to cryptocrystalline-microcrystalline; texture varies from glassy to variolitic, subvariolitic and intersertal.
VESICLES: Trace-2% (piece 9), ≤ 0.5 mm, round; filled by gray-green clay (saponite) \pm carbonate (parallel to alteration haloes). In piece 9, irregular cavities (≤ 2 mm) in the variolitic zone, are filled by green + yellow clay.
COLOR: Medium gray; 2.1PB 4.3/0.2 to 3.4PB 4.4/0.3
STRUCTURE: Pillow basalts.
ALTERATION: Slight to moderate; alteration haloes of green (saponite) + yellow (iddingsite) in pieces 9, 10 (8mm, clay + hematite), 12 (3mm), 15 (10mm, clay + celadonite? + pyrite + hematite) and 17 (3mm). In all cases, a band of carbonate filled vesicles occurs parallel to halo on inner side.
VEINS/FRACTURES: Pieces 9 and 10 have hairline veins filled with dark green saponite. Piece 13 is cut by a fractured network of veins lined by dark green saponite + orange iddingsite (no halo).
ADDITIONAL COMMENTS: Piece 11 is an aphyric, cryptocrystalline, vesicular ($\leq 5\%$) basalt. The vesicles (≤ 1 mm) are empty, lined by brown clay or rarely filled by carbonate. Trace phenocrysts: plagioclase + pyroxene (≤ 2 mm, euhedral) + olivine (≤ 1 mm, euhedral, replaced by green saponite.) (Rock out of place?)